

MODULE OF LOGIC OUTPUTS
SM4



USER'S MANUAL



Contents

1. APPLICATION.....	5
2. MODULE SET	6
3. BASIC REQUIREMENTS AND OPERATIONAL SAFETY	6
4. INSTALLATION	8
4.1. Module fitting	8
4.2. Terminal description.....	9
5. SERVICE	12
5.1. Description of the MODBUS protocol implementation	13
5.2. Description of the MODBUS protocol functions	14
5.3. Map of module registers	17
5.4. Set of module registers	18
6. TECHNICAL DATA.....	23
7. BEFORE A DAMAGE WILL BE DECLARED.....	25
8. ORDERING CODES.....	26
9. MAINTENANCE AND GUARANTEE.....	27

1. APPLICATION

The SM4 module of logic outputs is destined to control simple actuators through assignment of logic states received from the master device through the RS-485 interface.

The module can have 8 logic outputs or 4 relay outputs (depending on the execution) and RS-485 and RS-232 interfaces with MODBUS RTU and ASCII transmission protocols.

RS-232 and RS-485 ports are galvanically isolated from output signals and the supply.

The module programming is possible by means of the RS-485 or RS-232 port.

A connecting wire to connect with the PC computer (RS-232) is included to the SM4 module set.

Module parameters:

- 8 outputs of OC type or 4 relay outputs,
- RS-485 communication interface with MODBUS RTU and ASCII transmission protocols to work in industrial systems with an optical transmission signalling on LED diodes,
- Configurable baud rate: 2400....115200 bit/s

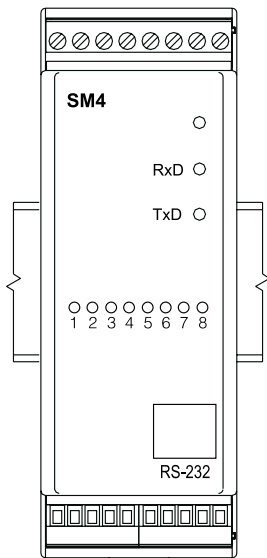

Fig.1. View of SM4 module

2. MODULE SET

The module set includes:

- SM4 module 1 pc,
- User's manual 1 pc,
- BU1005 plug with screw terminals 2 pcs,
- BU0204 plug with screw terminals 2 pcs,
- Hole plug of the RS-232 socket..... 1 pc,

3. BASIC REQUIREMENTS AND OPERATIONAL SERVICE

Symbols located in this service manual mean:



WARNING!

Warning of potential, hazardous situations. Especially important. One must acquaint with this before connecting the module.

The non-observance of notices marked by these symbols can occasion severe injuries of the personnel and the damage of the instrument.



CAUTION!

Designates a general useful note. If you observe it, handling of the module is made easier.

One must take note of this, when the instrument is working inconsistently to the expectations.

Possible consequences if disregarded !

In the security scope the module meets the requirements of the EN 61010 -standard.

Remarks concerning the operator safety:

1. General

- The SM4 module is destined to be mounted on a 35 mm mounting rail.
- Non-authorized removal of the required housing, inappropriate use, incorrect installation or operation creates the risk of injury to personnel or damage to equipment. For more detailed information please study the user's manual.
- All operations concerning transport, installation, and commissioning as well as maintenance must be carried out by qualified, skilled personnel and national regulations for the prevention of accidents must be observed.
- According to this basic safety information, qualified, skilled personnel are persons who are familiar with the installation, assembly, commissioning, and operation of

the product and who have qualifications necessary for their occupation.

2. Transport, storage

Please observe the notes on transport, storage and appropriate handling. Observe the climatic conditions given in Technical Data.

3. Installation

- The meter must be installed according to the regulation and instructions given in this user's manual.
- Ensure proper handling and avoid mechanical stress.
- Do not bend any components and do not change any insulation distances.
- Do not touch any electronic components and contacts.
- Instruments may contain electrostatically sensitive components, which can easily be damaged by inappropriate handling.
- Do not damage or destroy any electrical components since this might endanger your health!

4. Electrical connection

- Before switching the instrument on, one must check the correctness of connection to the network.
- In case of the protection terminal connection with a separate lead one must remember to connect it before the connection of the instrument to the mains.
- When working on live instruments, the applicable national regulations for the prevention of accidents must be observed.
- The electrical installation must be carried out according to the appropriate regulations (cable cross-sections, fuses, PE connection).
Additional information can be obtained from the user's guide.
- The documentation contains information about installation in compliance with EMC (shielding, grounding, filters and cables). These notes must be observed for all CE-marked products.
- The manufacturer of the measuring system or installed devices is responsible for the compliance with the required limit values demanded by the EMC legislation.

5. Operation

- Measuring systems including SM4 modules, must be equipped with protection devices according to the corresponding standard and regulations for prevention of accidents.
- After the instrument has been disconnected from the supply voltage, live components and power connections must not be touched immediately because capacitors can be charged.
- The housing must be closed during operation.
- The RS-232 socket serves only to connect the device (Fig. 5) working with the MODBUS protocol.

When the module socket is not used place the hole plug.

6. Maintenance and servicing.

- Please observe the manufacturer's documentation.

- Read all product-specific safety and application notes in this user's manual.
- Before taking the meter housing out, one must turn the supply off.
- The removal of the instrument housing during the warranty contract period may cause its cancellation.

4. INSTALLATION

4.1. Module fitting

The module is foreseen to be fixed on a 35 mm mounting rail (EN 60715)

The module housing is made of a non-flammable plastics.

Housing dimensions: 45 x 120 x 98 mm.

Connect external wires up to 2.5 mm² cross-section (from supply and interface side) and up to 1.5 mm² (from output signals side).

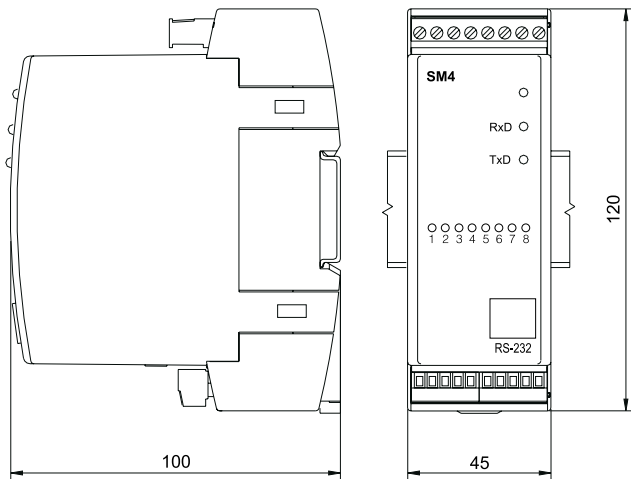

Fig.2. Overall and assembly dimensions

4.2. Terminal description

The supply and external signals must be connected in accordance with the description from the fig. 3 and tables 1 and 2.

Notice:

One must pay particular attention to the correct connection of external signals (see tables 1 and 2).

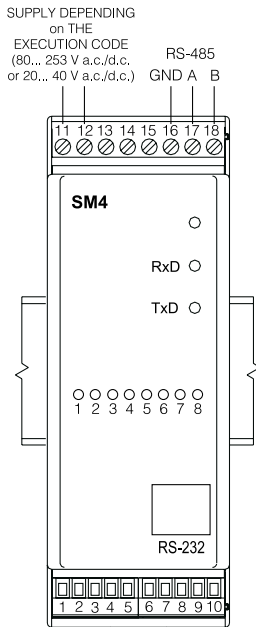

Fig.3. Electrical connections of the SM4 binary output module.

Three diodes are located on the frontal plate:

- **green** - signals the supply connection
- **green (RxD)** - signals the data reception by the module
- **yellow (TxD)** - signals the data transmission by the module

An example of logic output connection of OC type is presented below

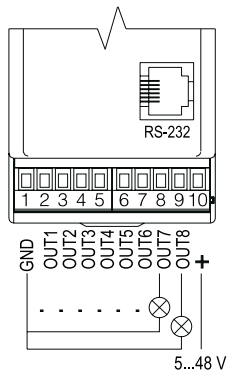

Fig. 4. Example of logic output connection of OC type.

*Description of SM4 logic output module
- Version with 8 outputs of OC type.*

Table 1

Terminal	Terminal description
1	GND line of logic outputs
2	OUT1 line - output No 1
3	OUT2 line - output No 2
4	OUT3 line - output No 3
5	OUT4 line - output No 4
6	OUT5 line - output No 5
7	OUT6 line - output No 6
8	OUT7 line - output No 7
9	OUT8 line - output No 8
10	+ line - output supply voltage
11, 12	Module supply lines
13...15	Not used
16	RS-485 interface mass with opto-isolation
17	Line A of RS-485 interface with opto-isolation
18	Line B of RS-485 interface with opto-isolation

*Description of SM4 logic output module
- Version with 4 relay outputs.*

Table 2

Terminal	Terminal description
1	GND line
2, 3	Output relay No 1
4, 5	Output relay No 2
6, 7	Output relay No 3
8, 9	Output relay No 4
10	5 V d.c. line
11, 12	Module supply lines
13...15	Not used
16	GND line of RS-485 interface with opto-isolation
17	Line A of RS-485 interface with opto-isolation
18	Line B of RS-485 interface with opto-isolation

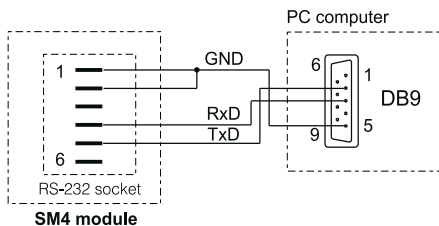
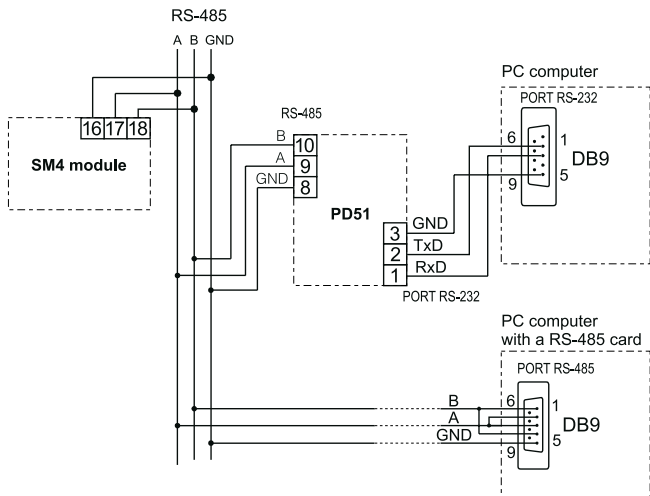

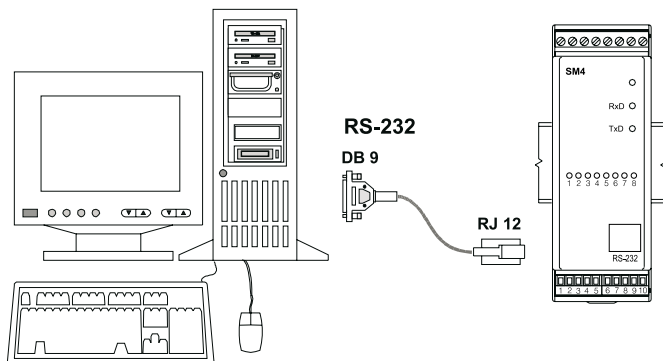

Fig. 5. Connection way of RS-485 and RS-232 interfaces

NOTICE:

Taking in consideration electromagnetic interference one must use screened wires to connect binary outputs signals and RS-485 interface signals. One must connect the screen to the protective terminal in a single point. The supply must be connected by a two-wire cable with an appropriate cross-section and protected by a cut-out.

The remove of the module housing during the guarantee period causes its cancellation.

5. SERVICE

After connecting external signals and switching the supply on, the SM4 module is ready to work.

The lighted green diode signals the module work. The green diode (Rx/D) signals the module polling, however the yellow diode (Tx/D) signals the module response. Diodes should ignite in cycles during the data transmission, both through the RS-232 and the RS-485 interface.

The signal „+“ (terminal 10), depending on the version, represents:

- for SM4 with 8 outputs of OC type - The terminal to which one must apply the supply voltage for OC output circuits, the level of possible voltage: 5... 50 V d.c.
- For SM4 with 4 relay outputs - the output 5 V with admissible load capacity 50 mA, one can use it to supply external circuits.

One can program all module parameters by means of RS-232 or RS-485. The RS-232 port has constant transmission parameters in accordance with technical data, what enables the connection with the module, even when programmed parameters of the RS-485 digital output are unknown (address, mode, rate). The RS-485 standard allows to the direct connection to 32 devices on a single serial link up to 1200 m. To connect a greater number of devices it is necessary to use additional intermediate-separating system e.g. converter/repeater of PD51 type).. The way of the interface connection is given in the user's manual (fig.5). To obtain the correct transmission, it is necessary to connect **A** and **B** lines in parallel with their counterparts in other devices. The connection must be carried out with a shielded wire. The shield must be connected to the protective terminal in a single point. The **GND** line serves to the additional protection of the interface line at long connections. One must connect it to the protective terminal (that is not necessary for the correct interface work). To obtain the connection with the PC computer through the RS-485 port, an RS-232/RS-485 converter (PD51) or an RS-485 interface card is indispensable. The marking of transmission lines for the card in the PC computer depends on the card manufacturer. To obtain the connection through the RS-232 port, the wire added to the module is sufficient. The connection way of both ports (RS-232 and RS-485) is shown on the fig. 5. The module can be connected to the device of master type only through one interface port. In case of a simultaneous connection of both ports, the module will work through the RS-232 interface.

5.1. Description of MODBUS protocol implementation

The transmission protocol describes ways of the information exchange between devices through serial links.

The MODBUS protocol has been implemented in the module in accordance with the PI-MBUS-300 Rev G specification of the Modicon company.

- Transducer address 1... 247
- Baud rate 2400, 4800, 9600, 19200, 38400, 57600,
115200 bit/s
- Working modes ASCII, RTU
- Information unit ASCII: 8N1, 7E1, 7O1
RTU: 8N2, 8E1, 8O1, 8N1
- Maximal response time 300 ms.

The parameter configuration of the serial link is described in the further part of the User's Manual. It consists on establishing the baud rate (**baud** parameter), device address (**Adr** parameter) and the information unit type (**Mode** parameter).

In case of the module connection with the computer through the RS-232 wire, the module set automatically following transmission parameters:

Baud rate: 9600 bps

Working mode: RTU 8N1

Address: 1

Notice: Each module connected to the communication network must:

- have a unique address, different from addresses of other devices connected to the network,
- identical baud rate and information unit type,
- the message sent with the address „0” is identified as the data transmission mode (transmission to many devices)

5.2. Description of the MODBUS protocol functions

Following functions of the MODBUS protocol has been implemented in the SM4 module series.

Description of the MODBUS protocol functions Table 3

Code	Meaning
01 (01h)	Readout of n-bit registers
03 (03h)	Readout of n-registers
04 (04 h)	Readout of n-input registers
06 (06 h)	Write of a single register
15 (0Fh)	Write of n-bit registers
16 (10h)	Write of n-registers
17 (11h)	Identification of slave device

Readout of n-registers (code 01h)

Function inaccessible in data transmission mode.

Example: Readout of 10 registers beginning from the register with the 0898h (2200) address:

Request:

Device address	Function	Register address		Number of registers		Checksum CRC
		Hi	Lo	Hi	Lo	
01	01	08	98	00	0A	3F 82

Answer:

Device address	Function	Number of bites	Value from the register 2200 - 2207	Value from the register 2208 - 2209	Checksumm CRC
01	01	02	BDh	01h	096C

Readout of n-registers (code 03h)

Function inaccessible in data transmission mode.

Example: Readout of 2 registers beginning from the register with the 1DBDh (7613) address:

Request:

Device address	Function	Register address Hi	Register address Lo	Number of registers Hi	Number of registers Lo	Checksum CRC
01	03	1D	BD	00	02	52 43

Answer:

Device address	Function	Number of bites	Value from the register 1DBD (7613)				Value from the register 1DBE (7614)				Checksum CRC
01	03	08	3F	80	00	00	40	00	00	00	42 8B

Readout of n-input registers (code 04h)

The function is inaccessible in the data transmission mode.

Example: readout of 1 register with the 0FA3h (4003) address

Request:

Device address	Function	Register address Hi	Register address Lo	Number of registers Hi	Number of registers Lo	Checksum CRC
01	04	0F	A3	00	01	C2 FC

Answer:

Device address	Function	Number of bytes	Value from the register 0FA3 (4003)		Checksum CRC
01	04	02	00	01	78 F0

Write of values into the register (code 06h)

The function is accessible in the data transmission mode.

Example: Write of the register with 1DBDh (7613) address.

Request:

Device address	Function	Register address Hi	Register address Lo	Value from the register 1DBD (7613)				Checksum CRC
01	06	1D	BD	3F	80	00	00	85 AD

Answer:

Device address	Function	Register address Hi	Register address Lo	Value from the register 1DBD (7613)				Checksum CRC
01	06	1D	BD	3F	80	00	00	85 AD

Write into n-bit registers (code 0Fh)

The function is accessible in the data transmission mode.

Example: Write of 2 registers beginning from the register with 0898h (2200) address

Request:

Device address	Function	Register address		Number of registers		Number of bytes	Value for the register 2200 - 2201	Checksum CRC
		Hi	Lo	Hi	Lo			
01	0F	08	98	00	02	01	03	BE 02

Answer:

Device address	Function	Register address		Number of registers		Checksum CRC
		Hi	Lo	Hi	Lo	
01	0F	08	98	00	02	57 85

Write into n-registers (code 10h)

The function is accessible in the data transmission mode.

Example: Write 2 registers beginning from the register with 1DBDh (7613) address.

Request:

Device address	Function	Register address		Number of registers		Number of bytes	Value from the register 1DBD (7613)				Value from the register 1DBE (7614)				Checksum CRC
		Hi	Lo	Hi	Lo		3F	80	00	00	40	00	00	00	
01	10	1D	BD	00	02	08	3F	80	00	00	40	00	00	00	03 09

Answer:

Device address	Function	Register address Hi	Register address Lo	Number of registers Hi	Number of registers Lo	Checksum (CRC)
01	10	1D	BD	00	02	D7 80

Report identifying the device (code 11h)

Request:

Device address	Function	Checksum (CRC)
01	11	C0 2C

Answer:

Device address	Function	Number of bytes	Device identifier	Device state	Software version number	Checksum
01	11	06	8C	FF	3F 80 00 00	A6 F3

Device address	- 01
Function	- function No: 0x11;
Number of bytes	- 0x06
Device Identifier	- 0x8C
Device state	- 0xFF
Software version No	- version implemented in the module: 1.00 XXXX - 4-byte variable of float type
Checksum	- 2 bytes in case of work in RTU mode - 1 byte in case of work in ASCII mode

5.3. Map of module registers

Map of the SM4 series module registers

Table 4

Range of addresses	Value type	Description
2200-2215	bool (1 bit)	The value is located in 1-bit register. Registers can be read out and written.
4000-4100	int (16 bits)	The value is located in 16-bit registers. The register content corresponds to the 32-bit register contents from the 7500 area. Registers are only for readout.
4200-4300	int (16 bits)	The value is located in 16-bit registers. The register content corresponds to the 32-bit register contents from the 7600 area. Registers can be read out and written.
7500-7600	float (32 bits)	The value is located in the 2-bit register. Registers are only for readout.
7600-7700	float (32 bits)	The value is located in the 32-bit register. Registers can be read out and written.

5.4. Set of module registers

Set of registers for readout the SM4 module.

Table 5

The value is located in 16-bit registers. The register contents corresponds to the content of 32-bit registers from the area 7500.	The value is located in 32-bit registers.	Name	Write(w) / Readout (r)	Unit	Quantity name
4000	7500	Identifier	r	-	Constant identifying the device (8C)
4001	7501	Status 1	r	-	Status 1 is a register describing current states of binary outputs.
4002	7502	Status 2	r	-	Status 2 is a register describing current transmission parameters.

Description of the status 1 register

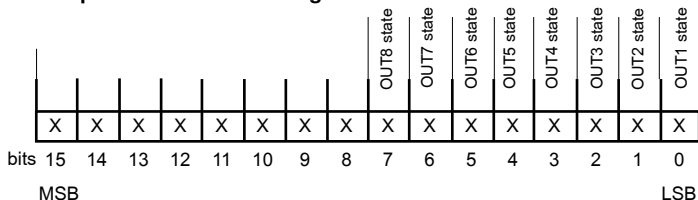

Bit-15...8 Not used

State 0

Bit-5 OUT6 output state

0 - inactive (0)

1 - active (1)

Bit-2 OUT3 output state

0 - inactive (0)

1 - active (1)

Bit-7 OUT8 output state

0 - inactive (0)

1 - active (1)

Bit-4 OUT5 output state

0 - inactive (0)

1 - active (1)

Bit-1 OUT2 output state

0 - inactive (0)

1 - active (1)

Bit-6 OUT7 output state

0 - inactive (0)

1 - active (1)

Bit-3 OUT4 output state

0 - inactive (0)

1 - active (1)

Bit-0 OUT1 output state

0 - inactive (0)

1 - active (1)

Description of the Status2 register

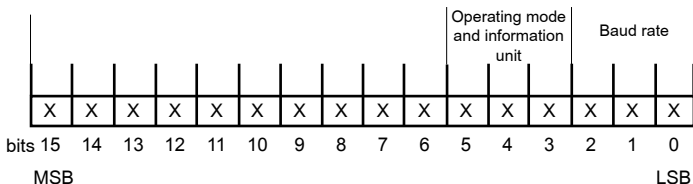

Bit-15...6 Not used

State 0

Bit-5...3 Working mode and information unit

000 - interface turned on

001 - 8N1 - ASCII

010 - 7E1 - ASCII

011 - 7O1 - ASCII

100 - 8N2 - RTU

101 - 8E1 - RTU

110 - 8O1 - RTU

111 - 8N1 - RTU

Bit-1...0 Baud rate

000 - 2400 bit/s

001 - 4800 bit/s

010 - 9600 bit/s

011 - 19200 bit/s

100 - 38400 bit/s

101 - 57600 bit/s

110 - 115200 bit/s

Set of registers for readout and write the SM4 module - in the version with eight outputs of OC type.

Table 6

The value is located in 1 bit registers. The register contents correspond to the contents of 32-bit registers from the area 7600	The value is located in 16 bit registers. The register contents correspond to the contents of 32-bit registers from the area 7600	The value is located in 32 bit registers.	Symbol	Write (w)/Readout (r)	Range	Description																
	4200	7600	Identifier	0	8C	SM4 identifier																
	4201	7601	Rate	w/r	0... 6	Baud rate of RS-485 interface transmission (bit/s)																
						<table border="1"> <tr><td>0</td><td>2400</td></tr> <tr><td>1</td><td>4800</td></tr> <tr><td>2</td><td>9600</td></tr> <tr><td>3</td><td>19 200</td></tr> <tr><td>4</td><td>38400</td></tr> <tr><td>5</td><td>57600</td></tr> <tr><td>6</td><td>115200</td></tr> </table>	0	2400	1	4800	2	9600	3	19 200	4	38400	5	57600	6	115200		
0	2400																					
1	4800																					
2	9600																					
3	19 200																					
4	38400																					
5	57600																					
6	115200																					
	4202	7602	Mode	w/r	0... 7	Transmission mode through RS-485 interface																
						<table border="1"> <tr><td>0</td><td>Interface switched off</td></tr> <tr><td>1</td><td>ASCII 8N1</td></tr> <tr><td>2</td><td>ASCII 7E1</td></tr> <tr><td>3</td><td>ASCII 7O1</td></tr> <tr><td>4</td><td>RTU 8N2</td></tr> <tr><td>5</td><td>RTU 8E1</td></tr> <tr><td>6</td><td>RTU 8O1</td></tr> <tr><td>7</td><td>RTU 8N1</td></tr> </table>	0	Interface switched off	1	ASCII 8N1	2	ASCII 7E1	3	ASCII 7O1	4	RTU 8N2	5	RTU 8E1	6	RTU 8O1	7	RTU 8N1
0	Interface switched off																					
1	ASCII 8N1																					
2	ASCII 7E1																					
3	ASCII 7O1																					
4	RTU 8N2																					
5	RTU 8E1																					
6	RTU 8O1																					
7	RTU 8N1																					
	4203	7603	Address	w/r	1... 247	Device address in the RS-485 interface network																
	4204	7604	Apply	w/r	0... 1	Register confirming changes of transmission parameters																
2200	4205	7605	Output 1	w/r	0... 1	State of the output 1																

2201	4206	7606	Output 2	w/r	0... 1	State of the output 2
2202	4207	7607	Output 3	w/r	0... 1	State of the output 3
2203	4208	7608	Output 4	w/r	0... 1	State of the output 4
2204	4209	7609	Output 5	w/r	0... 1	State of the output 5
2205	4210	7610	Output 6	w/r	0... 1	State of the output 6
2206	4211	7611	Output 7	w/r	0... 1	State of the output 7
2207	4212	7612	Output 8	w/r	0... 1	State of the output 8
2208	4213	7613	Output 1 Safety state	w/r	0... 1	Safety state of the output 1
2209	4214	7614	Output 2 Safety state	w/r	0... 1	Safety state of the output 2
2210	4215	7615	Output 3 Safety state	w/r	0... 1	Safety state of the output 3
2211	4216	7616	Output 4 Safety state	w/r	0... 1	Safety state of the output 4
2212	4217	7617	Output 5 Safety state	w/r	0... 1	Safety state of the output 5
2213	4218	7618	Output 6 Safety state	w/r	0... 1	Safety state of the output 6
2214	4219	7619	Output 7 Safety state	w/r	0... 1	Safety state of the output 7
2215	4220	7620	Output 8 Safety state	w/r	0... 1	Safety state of the output 8
	4221	7621	Admissible silent time on the bus	w/r	0...65000 sec	Setup time, after which, if there was not a transmission from SM4, the switching of outputs in a safe state follows.

Set of registers for readout and write the SM4 module in the version with four relay outputs.

Table 7

The value is located in 1 bit registers. The register contents correspond to the contents of 32-bit registers from the area 7600	The value is located in 16 bit registers. The register contents correspond to the contents of 32-bit registers from the area 7600	The value is located in 32 bit registers.	Symbol	Write (w)/Readout (r)	Range	Description
	4200	7600	Identifier	r	8C	SM4 identifier
	4201	7601	Rate	w/r	0... 6	Baud rate of RS-485 interface transmission (bit/s)
						0 2400
						1 4800
						2 9600
						3 19 200
						4 38400
						5 57600
						6 115200
	4202	7602	Mode	w/r	0... 7	Transmission mode through RS-485 interface
						0 Interface switched off
						1 ASCII 8N1
						2 ASCII 7E1
						3 ASCII 7O1
						4 RTU 8N2
						5 RTU 8E1
						6 RTU 8O1
						7 RTU 8N1
	4203	7603	Address	w/r	1... 247	Device address in the RS-485 interface network
	4204	7604	Apply	w/r	0... 1	Register confirming changes of transmission parameters
2200	4205	7605	Output 1	w/r	0... 1	State of the output 1

2201	4206	7606	Output 2	w/r	0... 1	State of the output 2
2202	4207	7607	Output 3	w/r	0... 1	State of the output 3
2203	4208	7608	Output 4	w/r	0... 1	State of the output 4
	4209	7609	–	–	–	Not used
	4210	7610	–	–	–	Not used
	4211	7611	–	–	–	Not used
	4212	7612	–	–	–	Not used
2208	4213	7613	Output 1 Safety state	w/r	0... 1	Set safety state of output 1
2209	4214	7614	Output 2 Safety state	w/r	0... 1	Set safety state of output 2
2210	4215	7615	Output 3 Safety state	w/r	0... 1	Set safety state of output 3
2211	4216	7616	Output 4 Safety state	w/r	0... 1	Set safety state of output 4
	4217	7617	–	–	–	Not used
	4218	7618	–	–	–	Not used
	4219	7619	–	–	–	Not used
	4220	7620	–	–	–	Not used
	4221	7621	Admissible silent time on the bus	w/r	0...65000 sec	Setup time, after which, if there was not a transmission from SM4, the switching of outputs in a safe state follows

6. TECHNICAL DATA

Transmission data:

a) RS-485 interface:

transmission protocol

ASCII

RTU

baud rate

address

MODBUS

8N1, 7E1, 7O1

8N2, 8E1, 8O1, 8N1

2400, 4800, 9600, 19200, 38400

57600, 115200 bit/s

1...247

b) RS-232 interface:	
transmission protocol	MODBUS
RTU	8N1
baud rate	9600
address	1
Load capacity of outputs	0.1 A for max. 2 active outputs simultaneously 0.05 A for all active outputs simultaneously
Load capacity of relay outputs (voltageless make contacts):	
- voltage	250 V a.c., 150 V d.c.
- current	5 A 30 V d.c., 250 V a.c.
- resistance load	1250 VA, 150 W
Module power consumption	≤ 4 VA
Rated operation conditions:	
- supply voltage	20... <u>24</u> ...50 V a.c./d.c. or 85... <u>230</u> ...253 V a.c./d.c.
- supply voltage frequency	40... <u>50/60</u> ...440 Hz
- ambient temperature	0... <u>23</u> ...55°C
- relative humidity	< 95% (inadmissible condensation)
- external magnetic field	< 400 A/m
- working position	any
Storage and handling conditions:	
- ambient temperature	- 20... 70°C
- relative humidity	< 95% (inadmissible condensation)
Ensured protection grades:	
- from frontal housing side	IP 40
- from terminal side	IP 20
Overall dimensions	45 x 120 x 100 mm
Weight	< 0.25 kg
Housing	adapted to be assembled on a rail

Electromagnetic compatibility:

- immunity EN 61000-6-2
- emission EN 61000-6-4

Safety requirements acc. to en EN 61010-1:

- installation category III
- pollution grade 2

Maximal phase-to-earth voltage:

- for supply circuits 300 V
- for other circuits 50 V

7. BEFORE A DAMAGE WILL BE DECLARED

SYMPTOMS	PROCEDURE	NOTES
1. The module green diode does not light up.	Check the connection of the network cable.	
2. The module does not establish communication with the master device through the RS-232 port. Lack of communication transmission signalling on RxD and TxD diodes.	Check if the cable is connected to the appropriate socket in the module. Check if the master device is set on the baud rate 9600, mode 8N1, address 1.	(RS-232 has constant transmission parameters)
3. The module does not establish communication with the master device through the RS-485 port. Lack of communication transmission signalling on RxD and TxD diodes.	Check if the cable is connected to the appropriate socket in the module. Check if the master device is set on the same transmission parameters as the module (baud rate, mode, address) In case of necessity to change transmission parameters when one cannot establish communication through RS-485, one must use the RS-232 port which has constant transmission parameters (in case of further problems see point 2). After changing RS-485 parameters into required, one can change over into the RS-885 port.	

8. ORDERING CODES

8-channel module of logic outputs - SM4	X	X	XX	X
Supply voltage:				
85... <u>230</u> ...253 V a.c./d.c.....	1			
20... <u>24</u> ...50 V a.c./d.c.....	2			
as ordered*	X			
Kind of outputs:				
8 outputs of OC type.....	1			
4 relay outputs	2			
Version:				
standard.....			00	
custom-made			XX	
Extra requirements;				
without an extra quality inspection certificate				8
with an extra quality inspection certificate				7
in compliance with user's agreement *				X

* The manufacturer will establish the code numbering

Ordering example:

Code **SM4 - 1. 2. 00 .1** means:

SM4 - 8-channel module of binary outputs

1 - supply voltage: 85...230...253 V a.c./d.c.,

2 - kind of outputs: with 4 relay outputs

00 - standard (catalogue) version

1 - with an extra quality inspection certificate

9. MAINTENANCE AND WARRANTY

The SM4 module does not require any periodical maintenance.
In case of some incorrect operations:

1. After the dispatch date and within the period stated in the warranty card

One should return the instrument to the Manufacturer's Quality Inspection Dept. If the instrument has been used in compliance with the instructions, the Manufacturer guarantees to repair it free of charge. The disassembling of the housing causes the cancellation of the granted warranty.

2. After the warranty period

One should send the instrument to repair it in a authorized service workshop.

Spare parts are available for the period of five years from the date of purchase.

The Manufacturer reserves the right to make changes in design and specifications of any products as engineering advances or necessity requires.



LUMEL

LUMEL S.A.

ul. Słubicka 4, 65-127 Zielona Góra, Poland
tel.: +48 68 45 75 100, fax +48 68 45 75 508
www.lumel.com.pl

Technical support:

tel.: (+48 68) 45 75 143, 45 75 141, 45 75 144, 45 75 140
e-mail: export@lumel.com.pl

Export department:

tel.: (+48 68) 45 75 130, 45 75 132
e-mail: export@lumel.com.pl

Calibration & Attestation:

e-mail: laboratorium@lumel.com.pl

SM4-09D
60-006-00-00334